

INSTALLATION INSTRUCTIONS

**Installation recommendation:

JBA recommends in most cases that the vehicle be taken to a reputable exhaust shop.

40-1520

2002 Dodge Ram quad cab/std. bed 4.7/5.9L V-8

40-1521

2002 Dodge Ram std. cab/short bed 4.7/5.9L V-8

TOOLS RECOMMENDED:

9/16 deep socket
ratchet
10mm wrench
15mm deep socket
prybar
rubber mallet
spray lubricant or penetrating oil
anti-seize
reciprocating saw or hack saw
pair of channel lock pliers

Part s List

A. Head pipe	1
B. Muffler, 24"	1
C. Tail pipe	1
D. Turn out	1
E. 2-1/2" clamp	1
F. 3" clamp hanger	1
G. 3" clamp hanger	1
H. 3" clamp	1

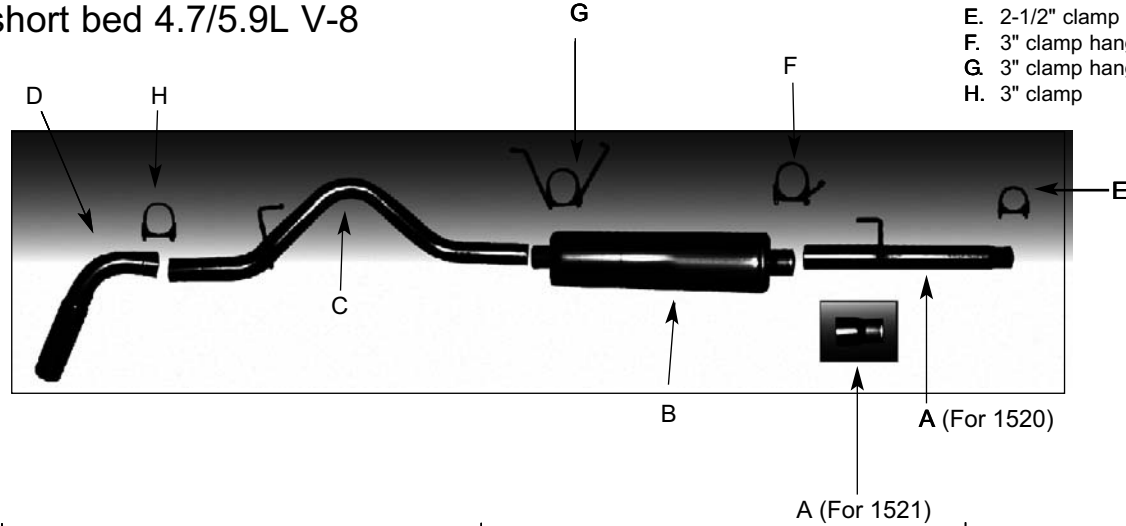

TO START :

1. Remove and inventory new JBA exhaust.
2. Disconnect negative battery cable and allow vehicle exhaust to cool.



3. With vehicle raised and properly supported, using a reciprocating saw or hack saw, cut tail pipe approximately 1" behind rear muffler clamp and in front of tail pipe hanger.



4. Spray lubricant on lower holes of front and rear tail pipe hanger rubber grommets.



5. Using a pair of channel lock pliers, remove hanger rods from bottom holes of two rear tail pipe rubber grommets.



6. Using a pair of channel lock pliers, remove front tail pipe hanger rod from bottom hole in rubber grommet.



7. Remove tail pipe from rear of vehicle.

8. Using some form of heat and force, disengage and remove muffler without damaging head pipe.

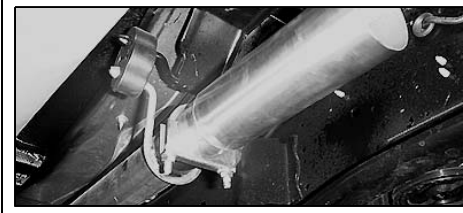
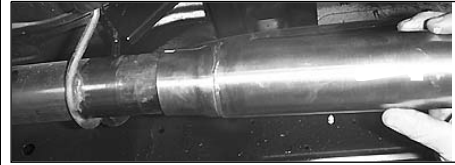

9. Align notch with locating pin and install head pipe (A) using the 2-1/2" clamp (E). Tighten completely with 9/16" deep wall socket. Note: Use anti-seize on threads.

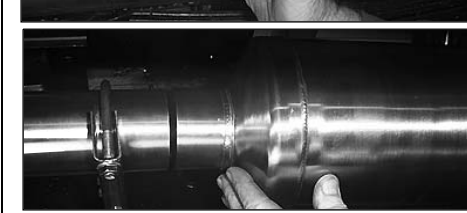

10. With JBA logo facing rear of vehicle, install muffler (B) over head pipe (A) making sure muffler bottoms out on slip joint.

11. Using the 3" clamp (F), tighten clamp completely using 9/16" deep wall socket.



12. Install tail pipe (C) from rear of vehicle with double hanger towards muffler.

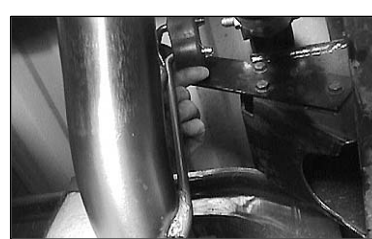

13. Install front two hangers on tail pipe (C) into lower holes of rubber grommet.

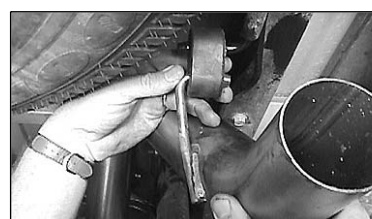

14. Install rear tail pipe hanger into rubber grommet. Align tail pipe and tighten 3" clamp (G) completely. Note: Use anti-seize on threads.



15. Install turn out clamp (H) over end of tail pipe (C) and into rubber grommet.

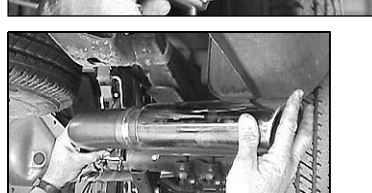
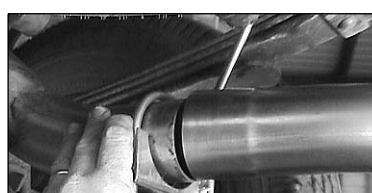

18. Install turn out (D) to end of tail pipe (C) rotate to desired position approx. 1" from body.

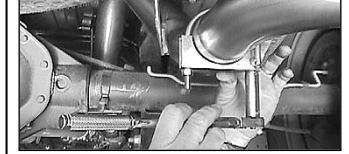

19. Tighten clamp (H) completely using 9/16" deep wall socket. Note: Use anti-seize on threads.

20. After installation, it is recommended that all clamps be retightened and joints tack welded in 3 spots.

21. Using a soft cloth, remove all prints from turnout tip.



22. Lower vehicle and reattach the negative battery cable.

NOTES:

- 1) It may be necessary to loosen and realign the spare tire for proper clearance.
- 2) All exhaust systems will expand about 1" rearward when exhaust temperature start to rise.
- 3) Use Anti-seize on threads of clamps.